

Data Sheet



Article number: 2761042922011

Description: KLEEblower KB429 2,2/2,6 kW
3x230/400V 50/60Hz Single stage

Measures

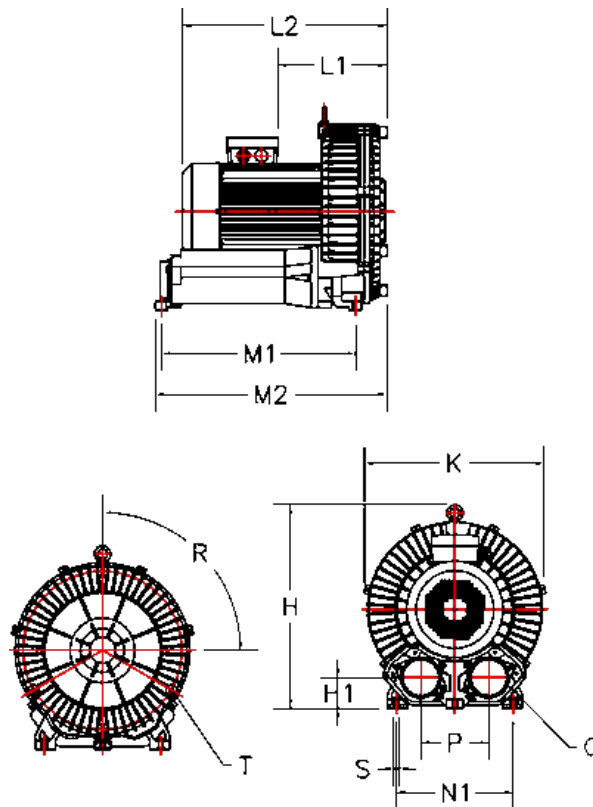

H = 338.5	N1 = 260
H1 = 47	Noise level dB 50/60Hz = 70/73
K = 332	P = 120
L1 = 126	Q = 2-PF 2" (NPT 2")
L2 = 320	R (degrees) = 3x120
M1 = 115	S = 4 x Ø14
M2 = 321.5	T = 3 - M8X1,25 - 15 dyb
N = 298	